

# Interior Signage Installation

Issued : May 4, 2020

**INNERFACE**

ARCHITECTURAL  
SIGNAGE, INC.

5849 PEACHTREE ROAD  
ATLANTA, GEORGIA 30341  
T 770 921 5566  
TF 800 445 4796  
F 770 279 1327  
INNERFACESIGN.COM

## SIGNAGE GUIDELINES

DESIGN + WAYFINDING  
INTERIOR

### Room Identification

- ADA Location Requirements 3-5
- ADA Height Requirements 6-9
- Puck System Mounting 10
- Perpendicular Mount 11

### Individual Letters

- Vinyl Installation 12
- Tape Mount Installation 13
- Stud Mount Installation 14

### Overhead Signage

- Suspended Ceiling 15
- Solid Ceiling 16
- Ceiling Frame 17

### Directory Cabinet

- Cleat Mount 18

2020.05.04



## DIRECTING PEOPLE BY DESIGN

5849 PEACHTREE ROAD  
ATLANTA, GEORGIA 30341  
T 770 921 5566  
TF 800 445 4796  
F 770 279 1327  
INNERFACESIGN.COM

# ROOM IDENTIFICATION: ADA LOCATION REQUIREMENTS

**SIGNAGE GUIDELINES**DESIGN + WAYFINDING  
INTERIOR

## Character Height

Minimum character height for ceiling or projecting wall mounted directional or informational signage is 2", provided that the sign is mounted no more than 10' high from the floor or ground surface.

5/8" minimum character height for all signs mounted between 40" and 70" from the floor or ground surface. This applies to all identification, informational, and directional signs. The 5/8" minimum does not apply to such regulatory signs as EMTALA, patients rights & responsibilities, marketing notices, etc. For specific instances, always contact the ADA hotline for clarification prior to manufacturing.

No sign shall be mounted lower than 40" from the floor or ground surface.

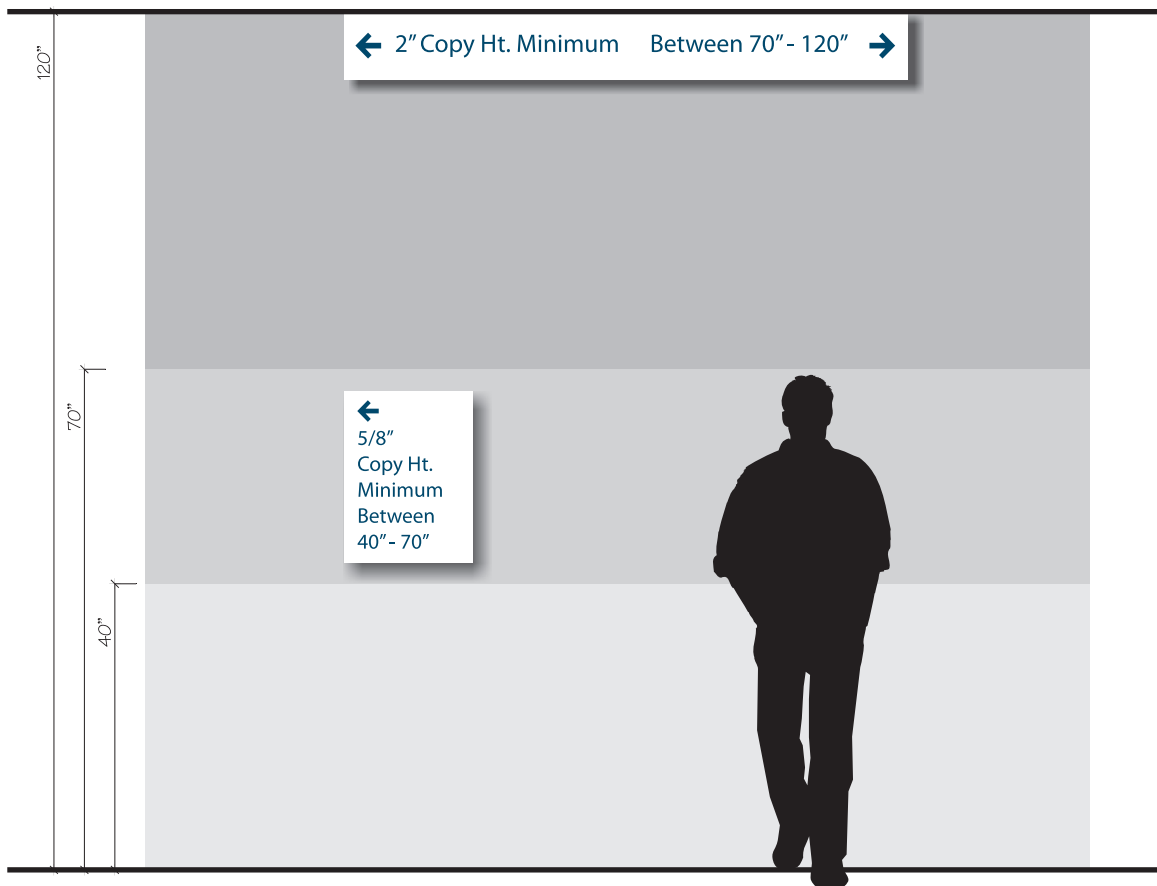

2020.05.04

**DIRECTING PEOPLE BY DESIGN**5849 PEACHTREE ROAD  
ATLANTA, GEORGIA 30341  
T 770 921 5566  
TF 800 445 4796  
F 770 279 1327  
INNERFACESIGN.COM

PAGE 3

# ROOM IDENTIFICATION: ADA LOCATION REQUIREMENTS

**SIGNAGE GUIDELINES**

DESIGN + WAYFINDING  
INTERIOR

### Tactile Sign Mounting

Tactile signs are to be mounted on the latch side of the door, 2" from the door frame, 48" minimum, 60" maximum measured to the baseline of the raised characters. Ideally, but not a requirement, braille should be placed at one consistent height whenever possible.

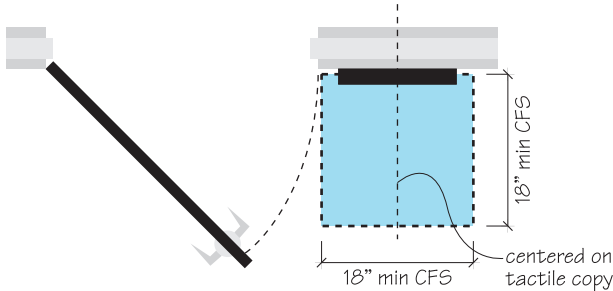

18" of clear free space (CFS) must be maintained at the sign location.

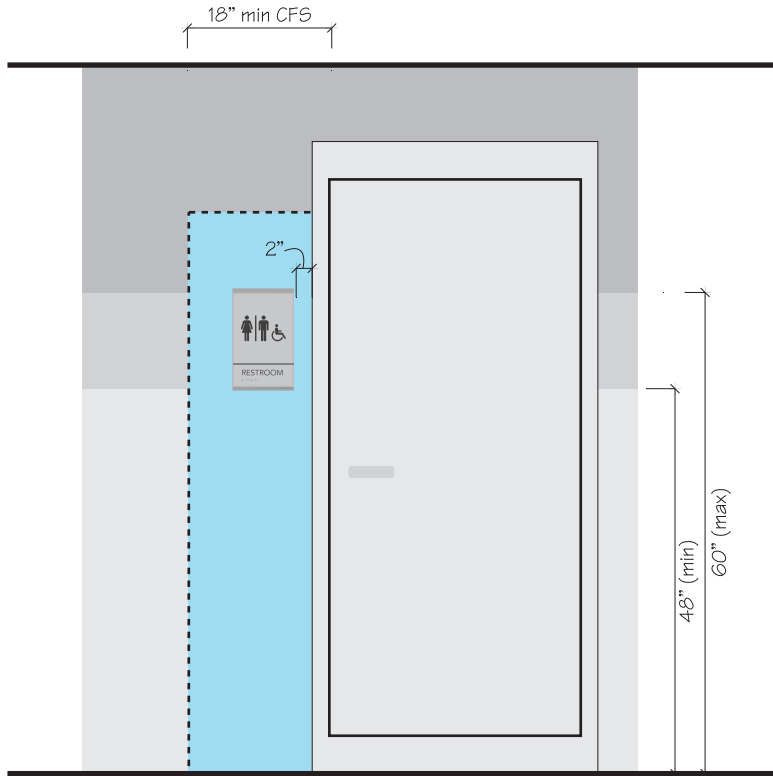

# ROOM IDENTIFICATION: ADA LOCATION REQUIREMENTS

**SIGNAGE GUIDELINES**

DESIGN + WAYFINDING  
INTERIOR

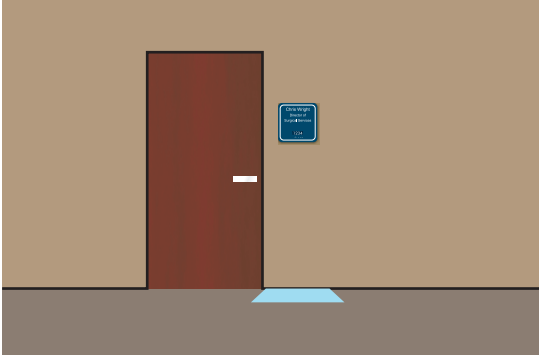

Ideal Location on Latch Side of Door



Located on Push Side of Door if Door Opens Inward and Does Not have a Hold-open Device



Inset door opening, then Nearest Adjacent Wall

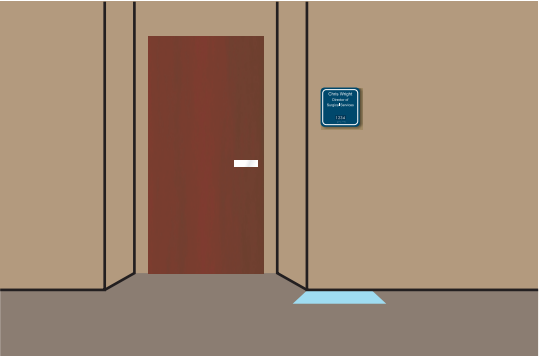

Inset door opening, No space on Latch Side

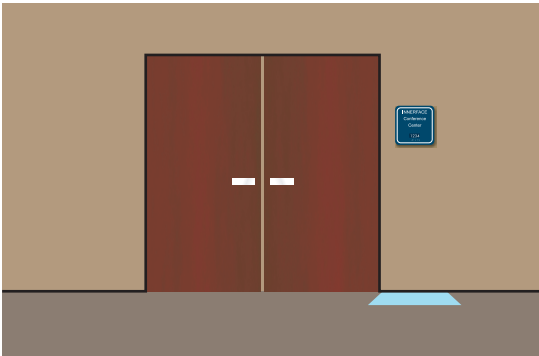

Double doors with 2 Active Leaves

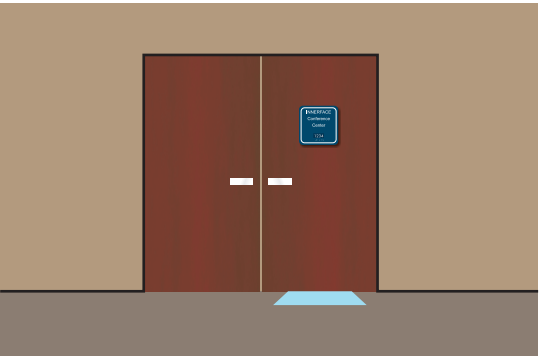

Double Doors with 1 Active Leaf

2020.05.04



**DIRECTING PEOPLE BY DESIGN**

5849 PEACHTREE ROAD  
ATLANTA, GEORGIA 30341  
T 770 921 5566  
TF 800 445 4796  
F 770 279 1327  
INNERFACESIGN.COM

# ROOM IDENTIFICATION: ADA HEIGHT REQUIREMENTS

**SIGNAGE GUIDELINES**

DESIGN + WAYFINDING  
INTERIOR

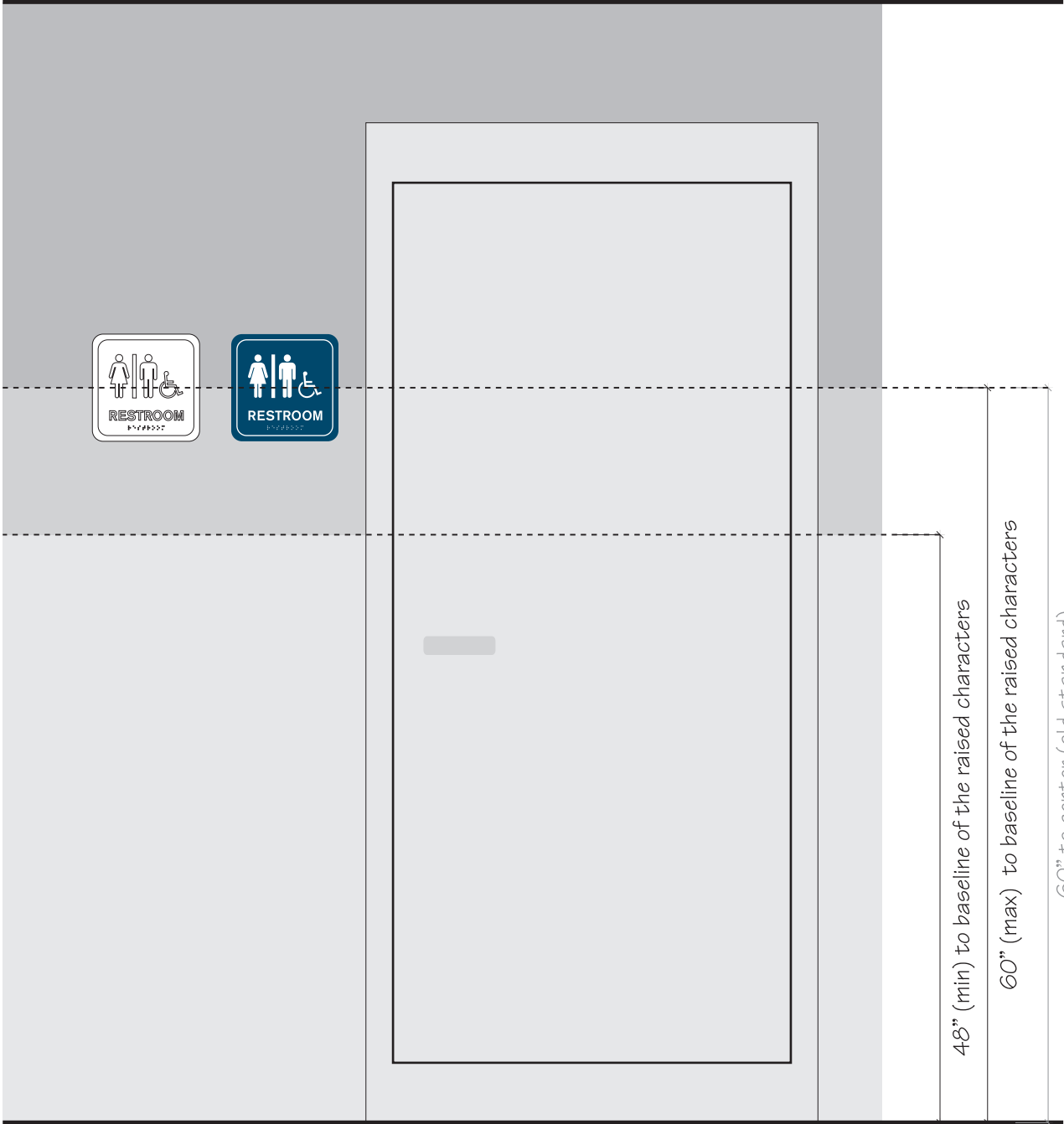

2020.05.04



**DIRECTING PEOPLE BY DESIGN**

5849 PEACHTREE ROAD  
ATLANTA, GEORGIA 30341  
T 770 921 5566  
TF 800 445 4796  
F 770 279 1327  
INNERFACESIGN.COM

# ROOM IDENTIFICATION: ADA HEIGHT REQUIREMENTS

**SIGNAGE GUIDELINES**

DESIGN + WAYFINDING  
INTERIOR

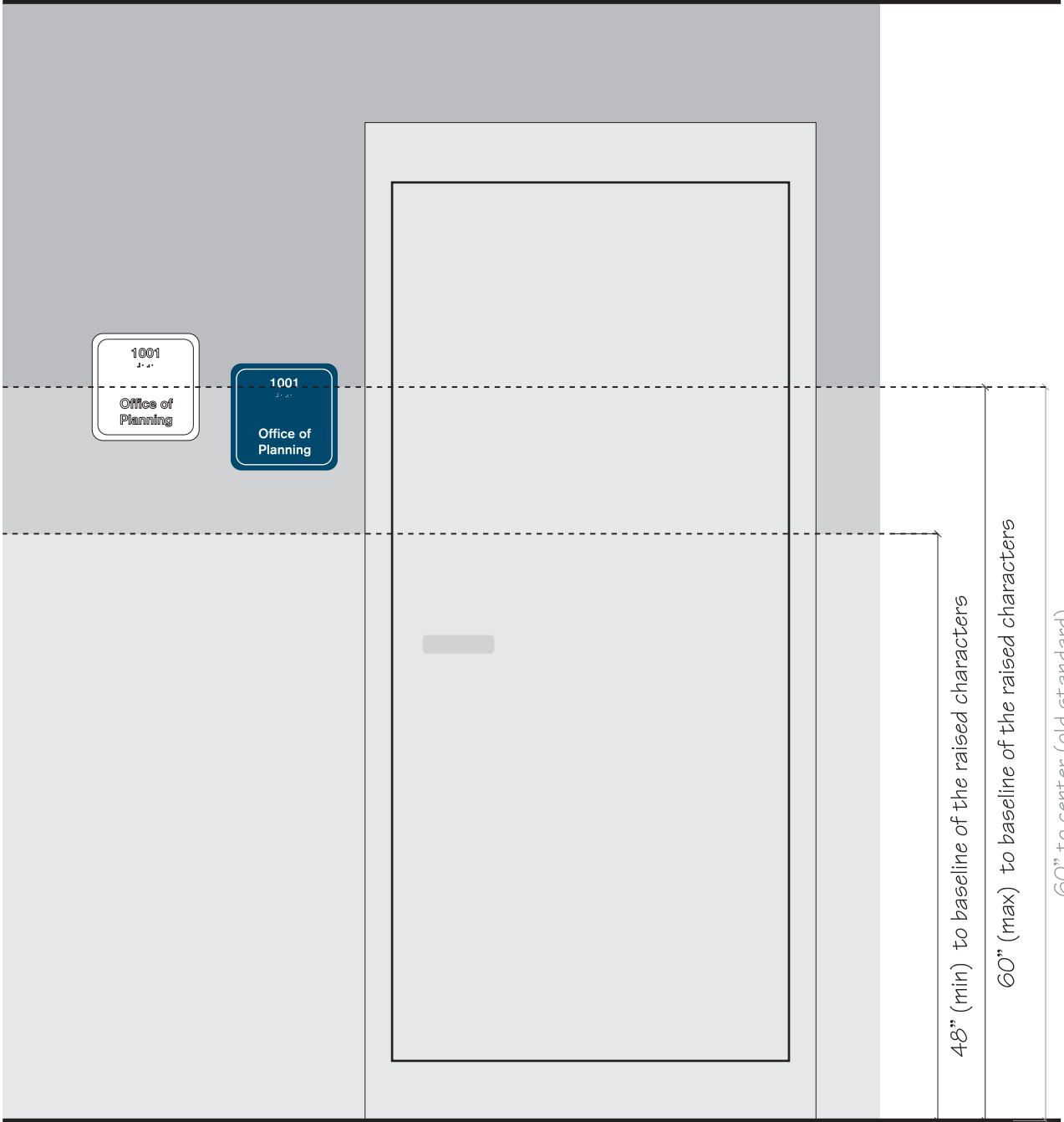

2020.05.04



**DIRECTING PEOPLE BY DESIGN**

5849 PEACHTREE ROAD  
ATLANTA, GEORGIA 30341  
T 770 921 5566  
TF 800 445 4796  
F 770 279 1327  
INNERFACESIGN.COM

# ROOM IDENTIFICATION: ADA HEIGHT REQUIREMENTS

**SIGNAGE GUIDELINES**

DESIGN + WAYFINDING  
INTERIOR

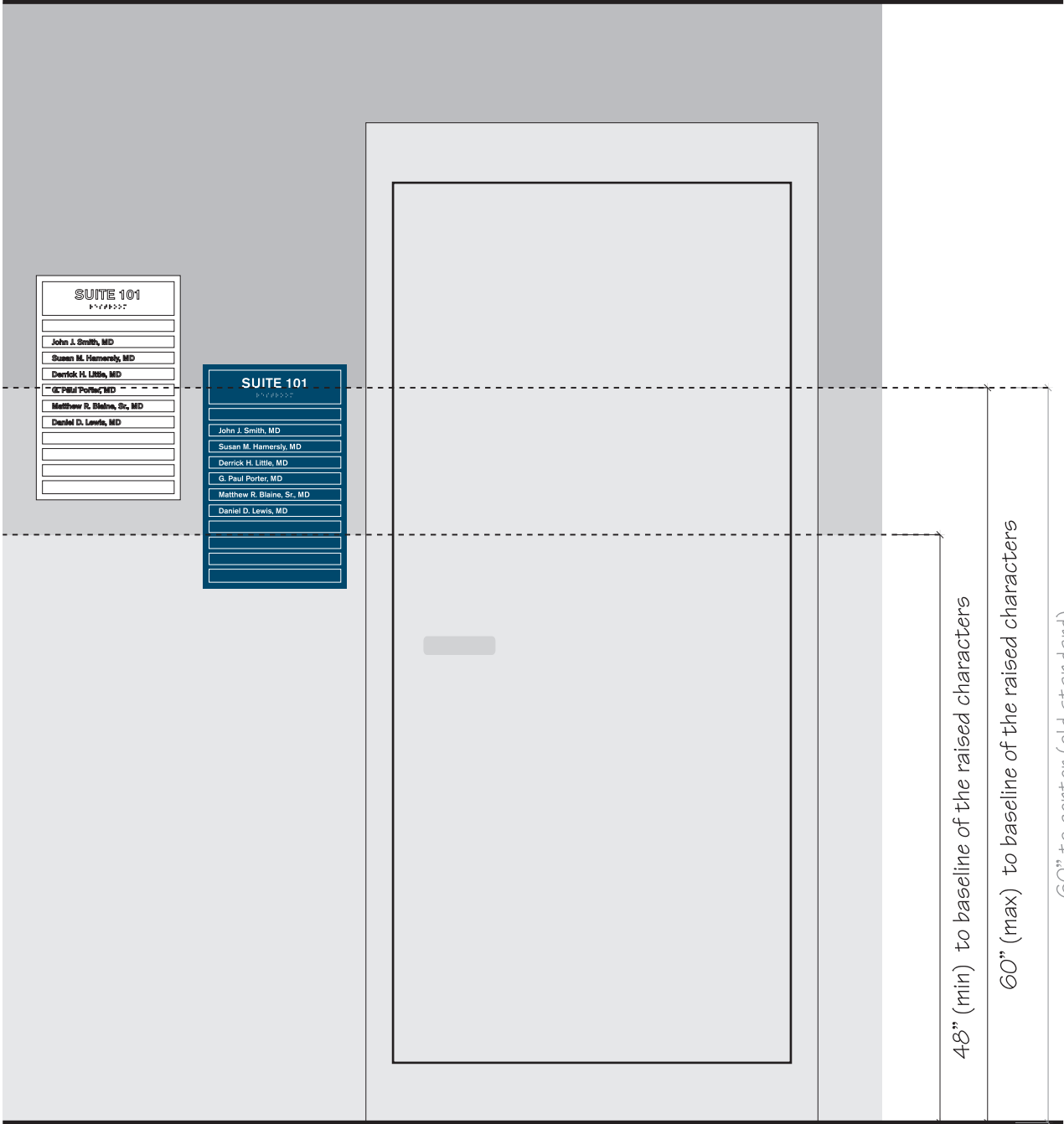

2020.05.04



**DIRECTING PEOPLE BY DESIGN**

5849 PEACHTREE ROAD  
ATLANTA, GEORGIA 30341  
T 770 921 5566  
TF 800 445 4796  
F 770 279 1327  
INNERFACESIGN.COM



# ROOM IDENTIFICATION: ADA HEIGHT REQUIREMENTS

**SIGNAGE GUIDELINES**

DESIGN + WAYFINDING  
INTERIOR

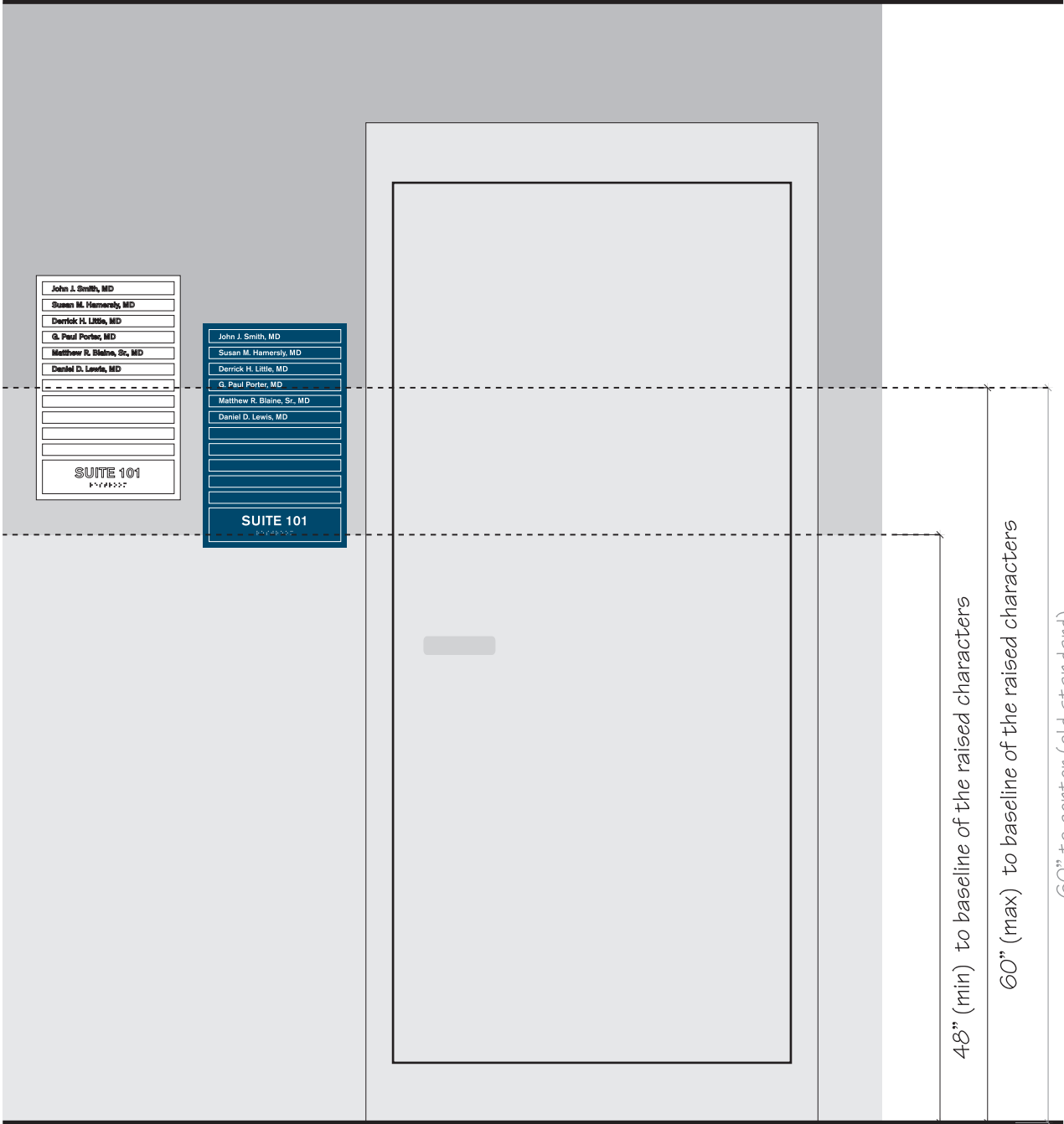

2020/05.04



**DIRECTING PEOPLE BY DESIGN**

5849 PEACHTREE ROAD  
ATLANTA, GEORGIA 30341  
T 770 921 5566  
TF 800 445 4796  
F 770 279 1327  
INNERFACESIGN.COM

# ROOM IDENTIFICATION: PUCK SYSTEM MOUNTING

**SIGNAGE GUIDELINES**

DESIGN + WAYFINDING  
INTERIOR

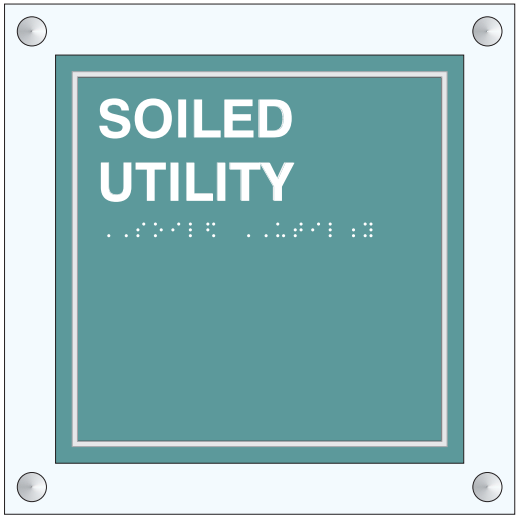

Front View

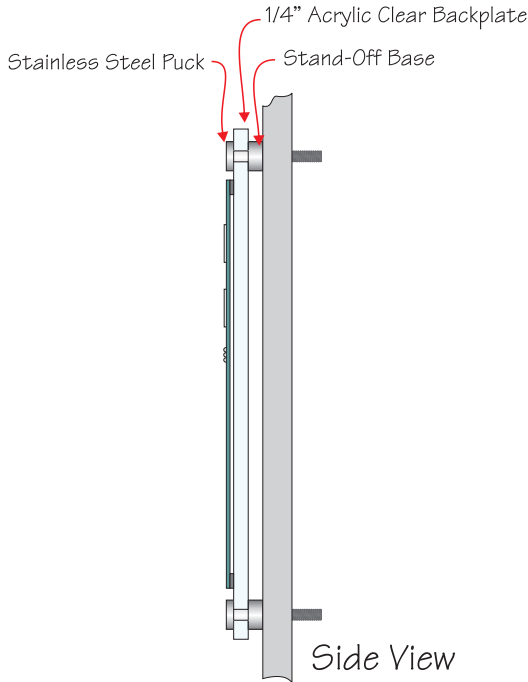

Side View

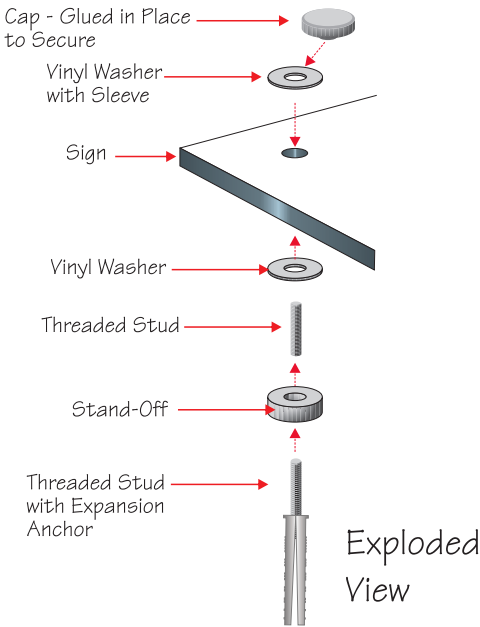

Exploded  
View

2020.05.04



**DIRECTING PEOPLE BY DESIGN**

# ROOM/PLACE IDENTIFICATION: PERPENDICULAR MOUNT

**SIGNAGE GUIDELINES**

DESIGN + WAYFINDING  
INTERIOR

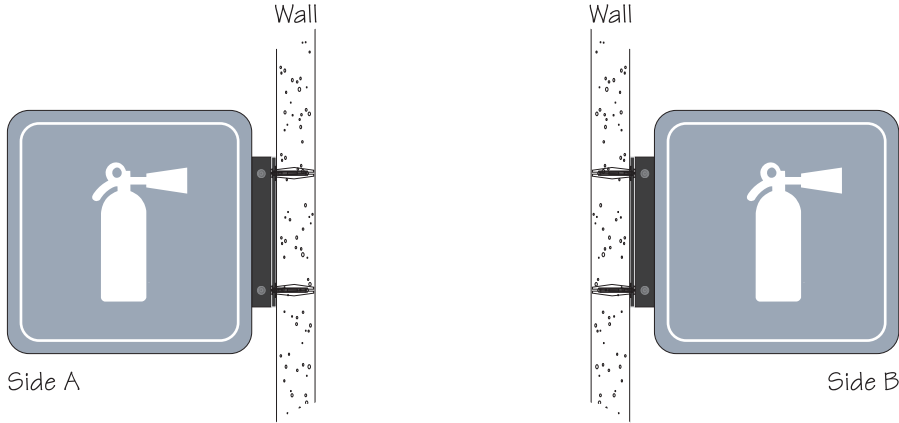
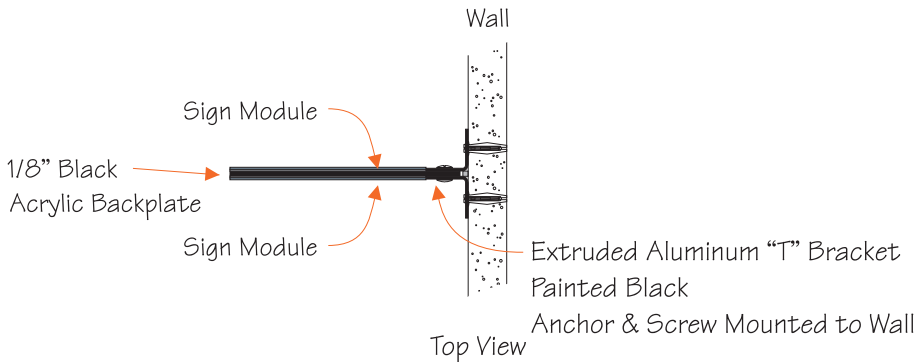
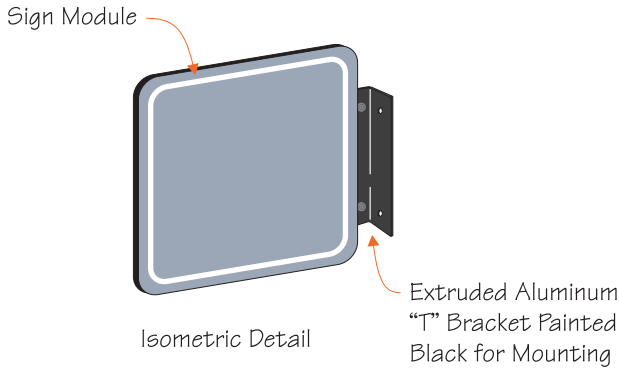

Double-Sided  
Perpendicular Mount  
Mounted to Wall Surface

2020.05.04



**DIRECTING PEOPLE BY DESIGN**

5849 PEACHTREE ROAD  
ATLANTA, GEORGIA 30341  
T 770 921 5566  
TF 800 445 4796  
F 770 279 1327  
INNERFACESIGN.COM

# INDIVIDUAL LETTERS: VINYL INSTALLATION

**SIGNAGE GUIDELINES**

DESIGN + WAYFINDING  
INTERIOR

Step 1.  
Measure and layout  
prespaced vinyl  
lettering

Measure Twice!

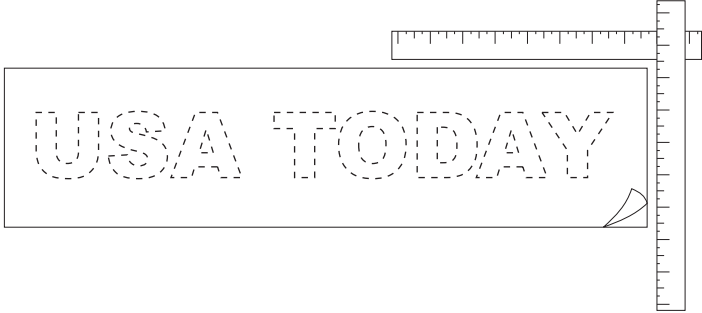

Step 2  
Tape lettering in  
place by making  
a "hinge" on the  
top.

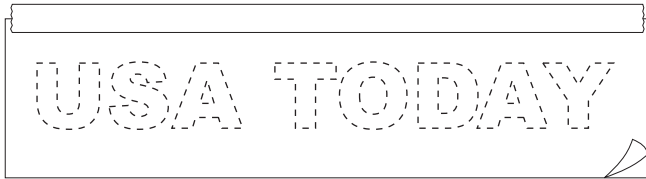

Step 3  
Lift letter set up to  
remove the backing  
paper. This leaves  
the letters on the  
masking tape.

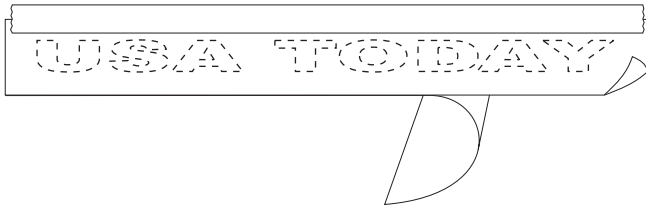

Step 4  
Begin to lay the  
lettering in place  
gradually.  
Squeegee it in place  
pushing out bubbles  
as you go. Go Slow!

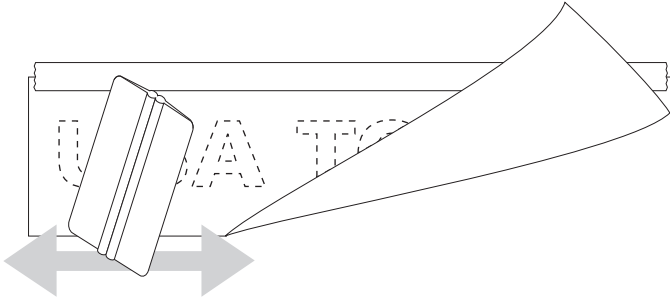

Step 5  
Peel the mask tape  
and hinge from the  
glass leaving the  
vinyl lettering.

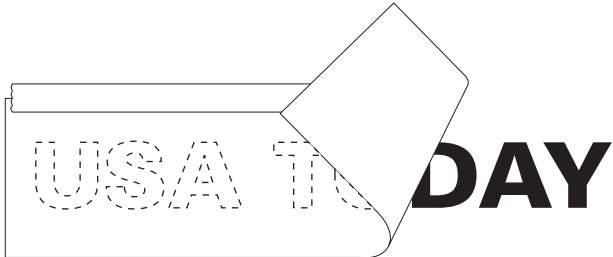

2020/05.04



**DIRECTING PEOPLE BY DESIGN**

5849 PEACHTREE ROAD  
ATLANTA, GEORGIA 30341  
T 770 921 5566  
TF 800 445 4796  
F 770 279 1327  
INNERFACESIGN.COM

# INDIVIDUAL LETTERS: TAPE MOUNT INSTALLATION

**SIGNAGE GUIDELINES**

DESIGN + WAYFINDING  
INTERIOR

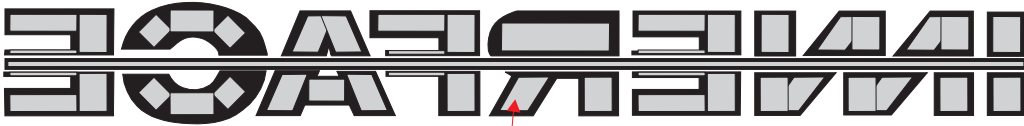

High Bond Vinyl Tape with  
Paper Backing on  
Back of Letters -  
Peel Paper off Prior to Installation

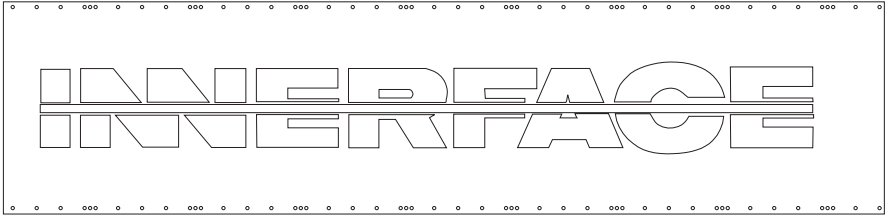

Paper Template and Taped Letters  
Provided by Innerface

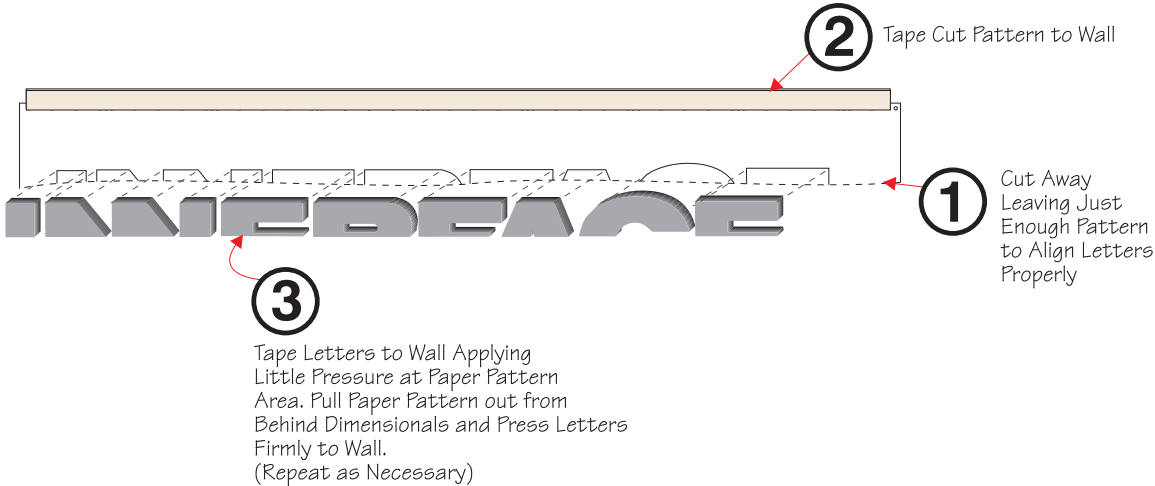

2020.05.04



**DIRECTING PEOPLE BY DESIGN**

5849 PEACHTREE ROAD  
ATLANTA, GEORGIA 30341  
T 770 921 5566  
TF 800 445 4796  
F 770 279 1327  
INNERFACESIGN.COM

## INDIVIDUAL LETTERS: STUD MOUNT INSTALLATION

### SIGNAGE GUIDELINES

DESIGN + WAYFINDING  
INTERIOR

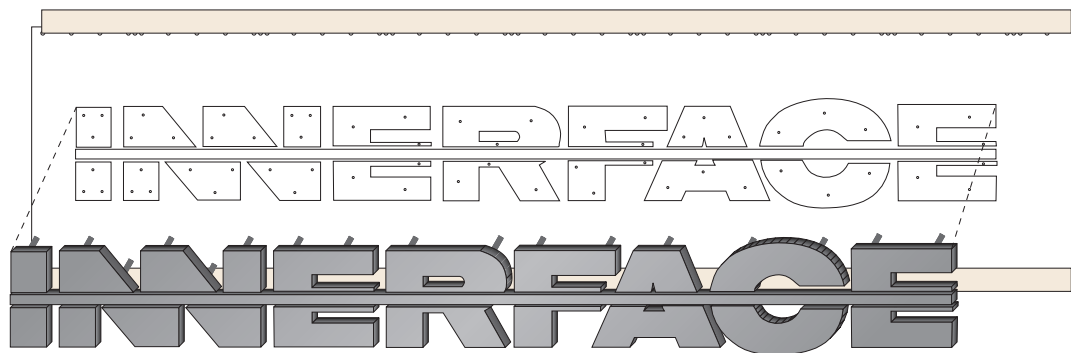
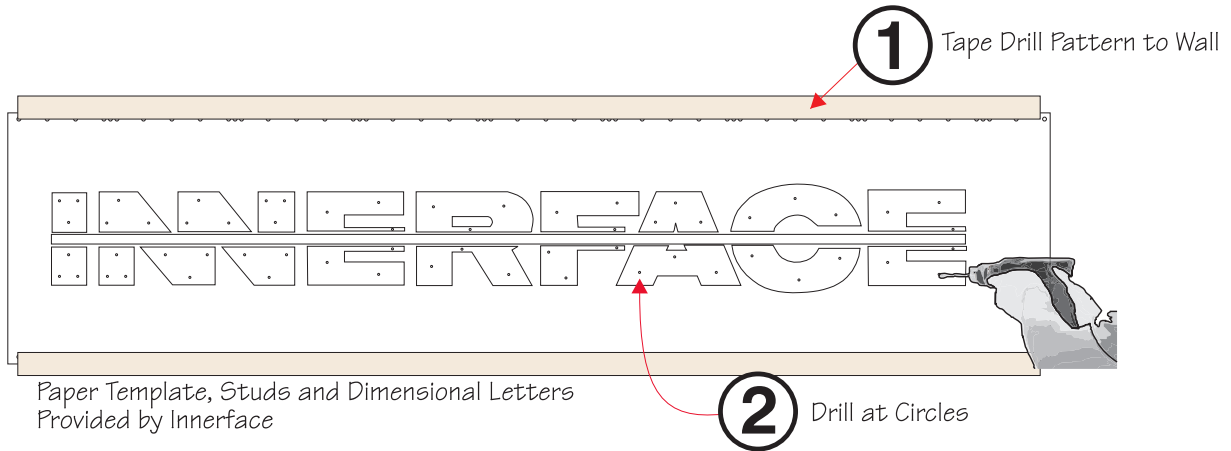

**3**

Fill Holes with Silicone Adhesive and, Insert Studs into Drilled Holes. Pull Paper Pattern out from Behind Dimensionals.

2020.05.04



### DIRECTING PEOPLE BY DESIGN

5849 PEACHTREE ROAD  
ATLANTA, GEORGIA 30341  
T 770 921 5566  
TF 800 445 4796  
F 770 279 1327  
INNERFACESIGN.COM

# OVERHEAD SIGNAGE: SUSPENDED CEILING

**SIGNAGE GUIDELINES**

DESIGN + WAYFINDING  
INTERIOR

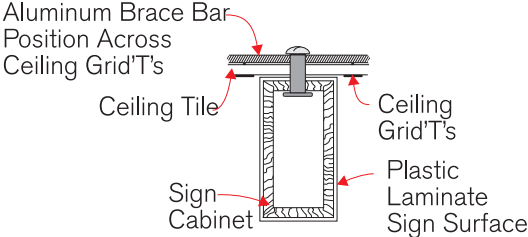

SUSPENDED CEILING  
DETAIL

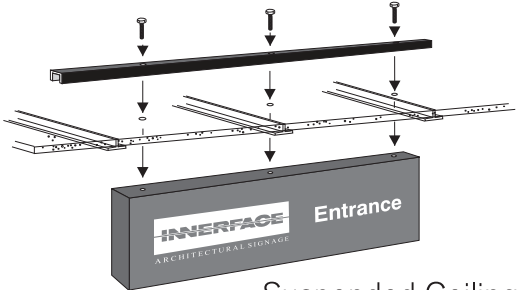

Suspended Ceiling  
Isometric Detail

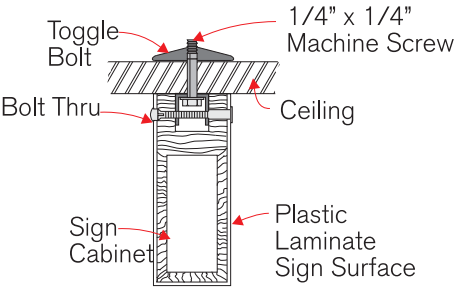

SOLID CEILING  
DETAIL

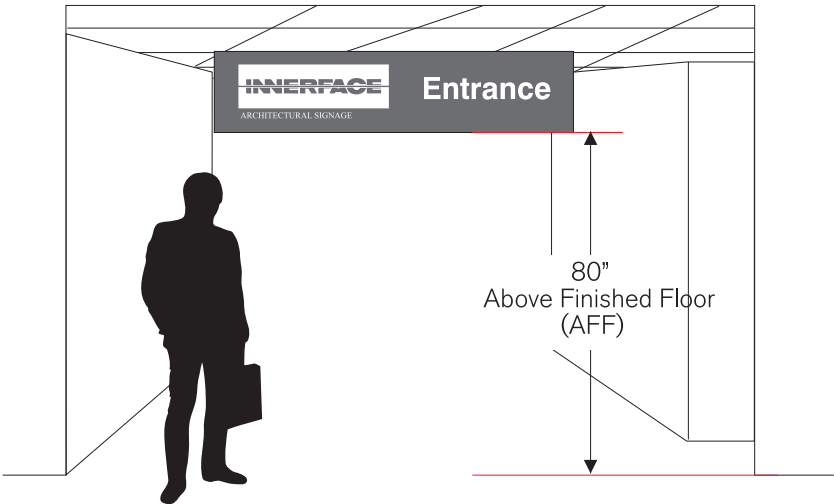

ELEVATION DETAIL

2020.05.04



**DIRECTING PEOPLE BY DESIGN**

5849 PEACHTREE ROAD  
ATLANTA, GEORGIA 30341  
T 770 921 5566  
TF 800 445 4796  
F 770 279 1327  
INNERFACESIGN.COM

# OVERHEAD SIGNAGE: SOLID CEILING

**SIGNAGE GUIDELINES**

DESIGN + WAYFINDING  
INTERIOR

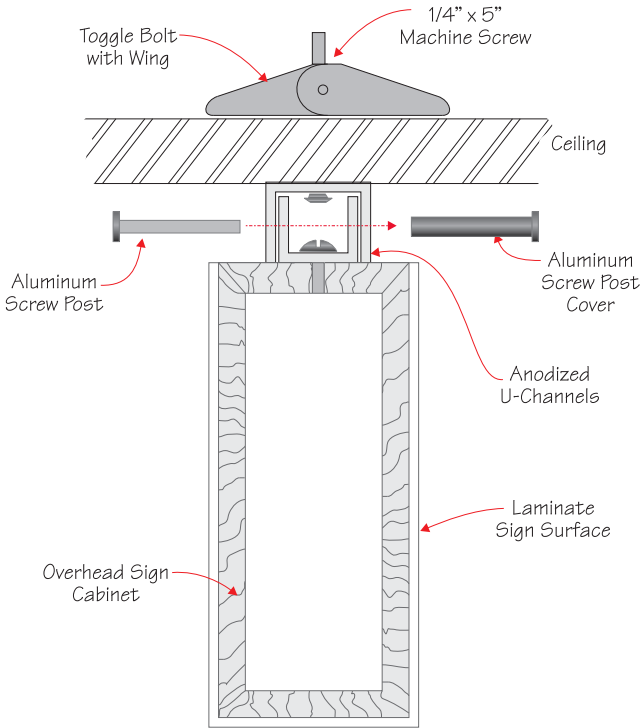

SOLID CEILING  
MOUNTING DETAIL

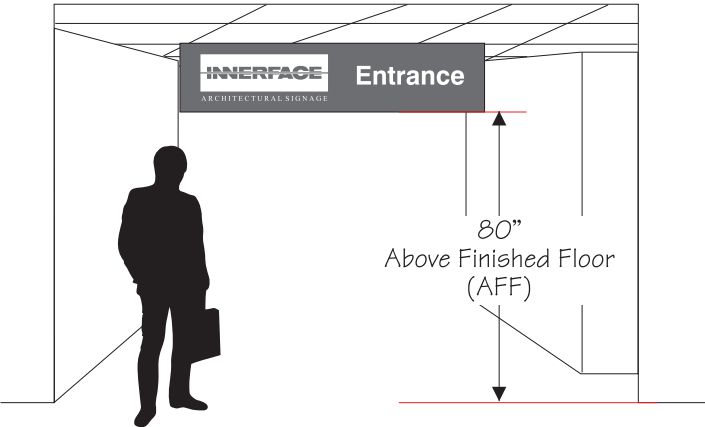

ELEVATION DETAIL

2020.05.04



**DIRECTING PEOPLE BY DESIGN**

5849 PEACHTREE ROAD  
ATLANTA, GEORGIA 30341  
T 770 921 5566  
TF 800 445 4796  
F 770 279 1327  
INNERFACESIGN.COM



# OVERHEAD SIGNAGE: CEILING FRAME

**SIGNAGE GUIDELINES**

DESIGN + WAYFINDING  
INTERIOR

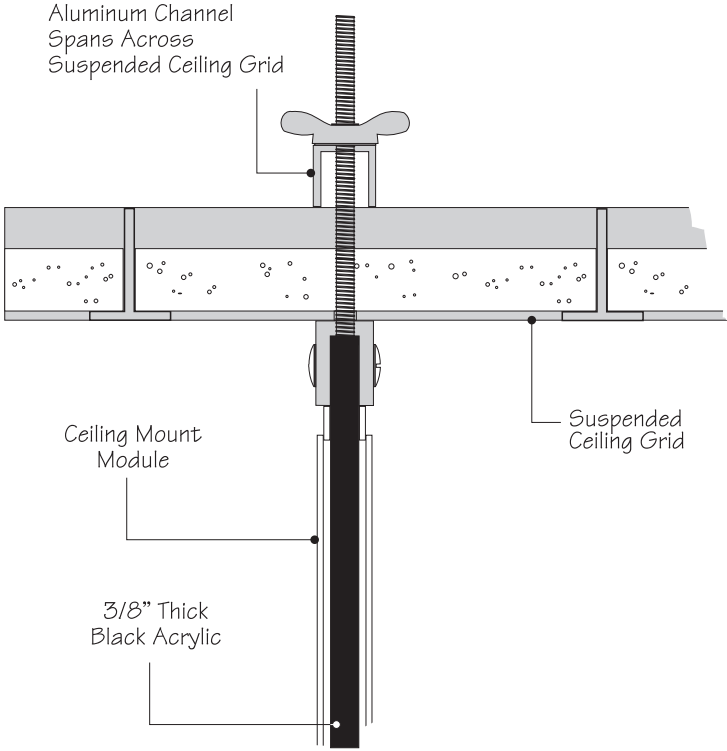
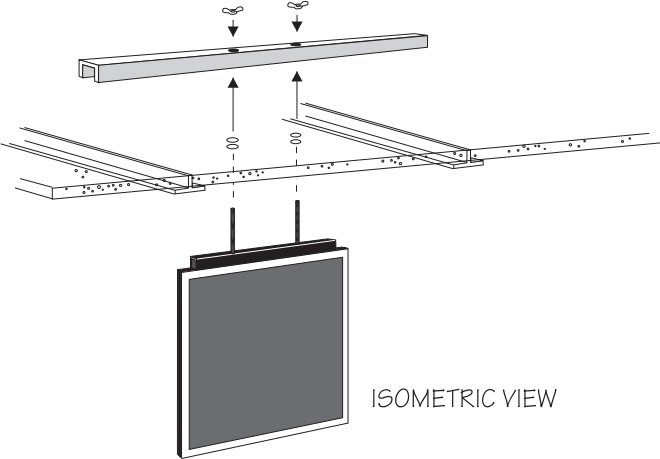

2020.05.04



**DIRECTING PEOPLE BY DESIGN**

# DIRECTORY CABINET: CLEAT MOUNT

**SIGNAGE GUIDELINES**

DESIGN + WAYFINDING  
INTERIOR

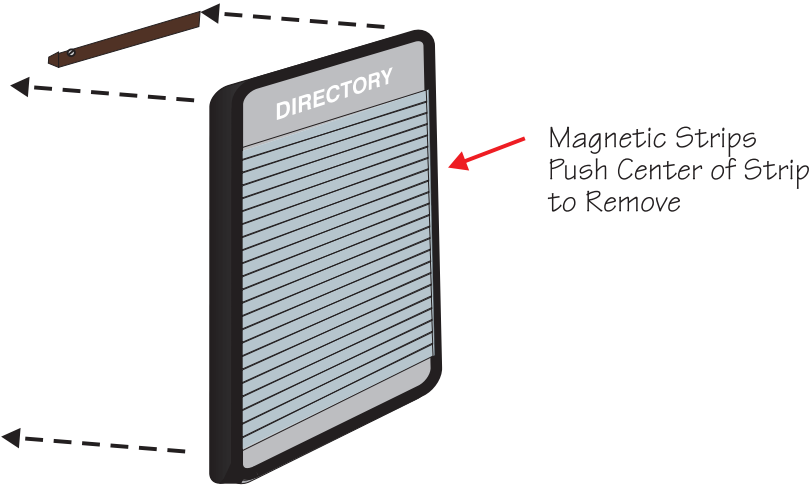
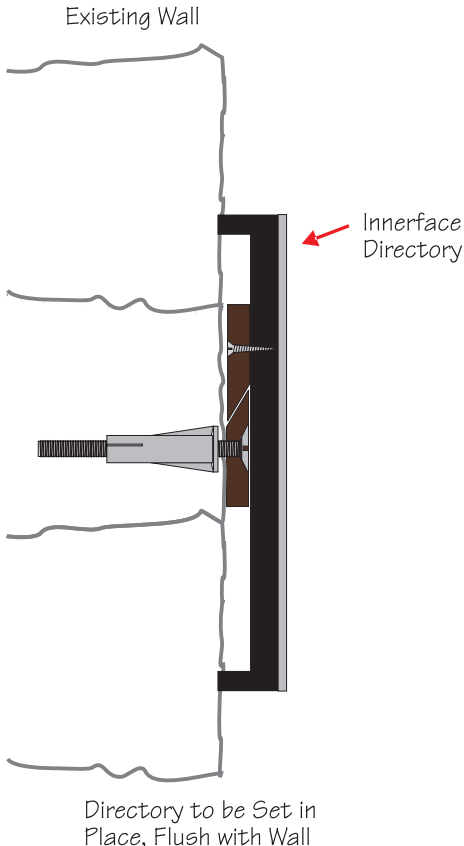
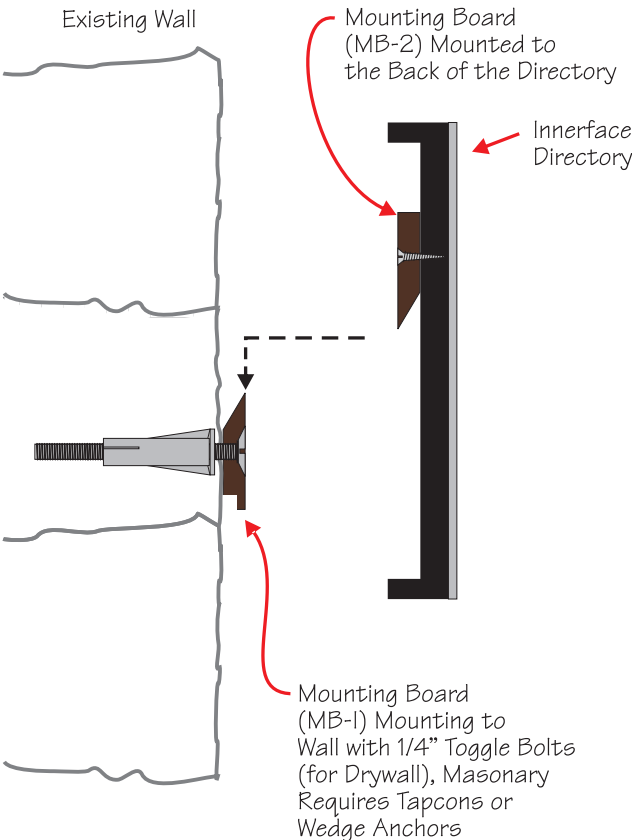

2020.05.04



**DIRECTING PEOPLE BY DESIGN**

5849 PEACHTREE ROAD  
ATLANTA, GEORGIA 30341  
T 770 921 5566  
TF 800 445 4796  
F 770 279 1327  
INNERFACESIGN.COM